

### Silicon Planar PIN Photodiode

#### PD70-01C/TR7

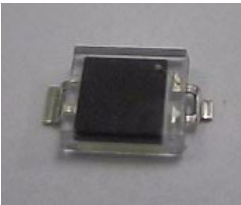

#### Features

- High sensitivity
- Low capacitance
- Short switching time
- Wide temperature range
- Small package
- Pb free
- The product itself will remain within RoHS compliant version.

#### Descriptions

- The PD70-01C/TR7 is high sensitivity, fast switching times, low capacitance, compact size, and lack of measurable degradation make it suitable for diverse applications, such as TV and appliance remote control, IR sound transmission, video recorders, and measurement and control.

#### Applications

- High speed photo detector
- Copier
- Elevator

#### Device Selection Guide

Part Category	Chip Material	Lens Color
PD	Silicon	Water clear

Package Dimensions

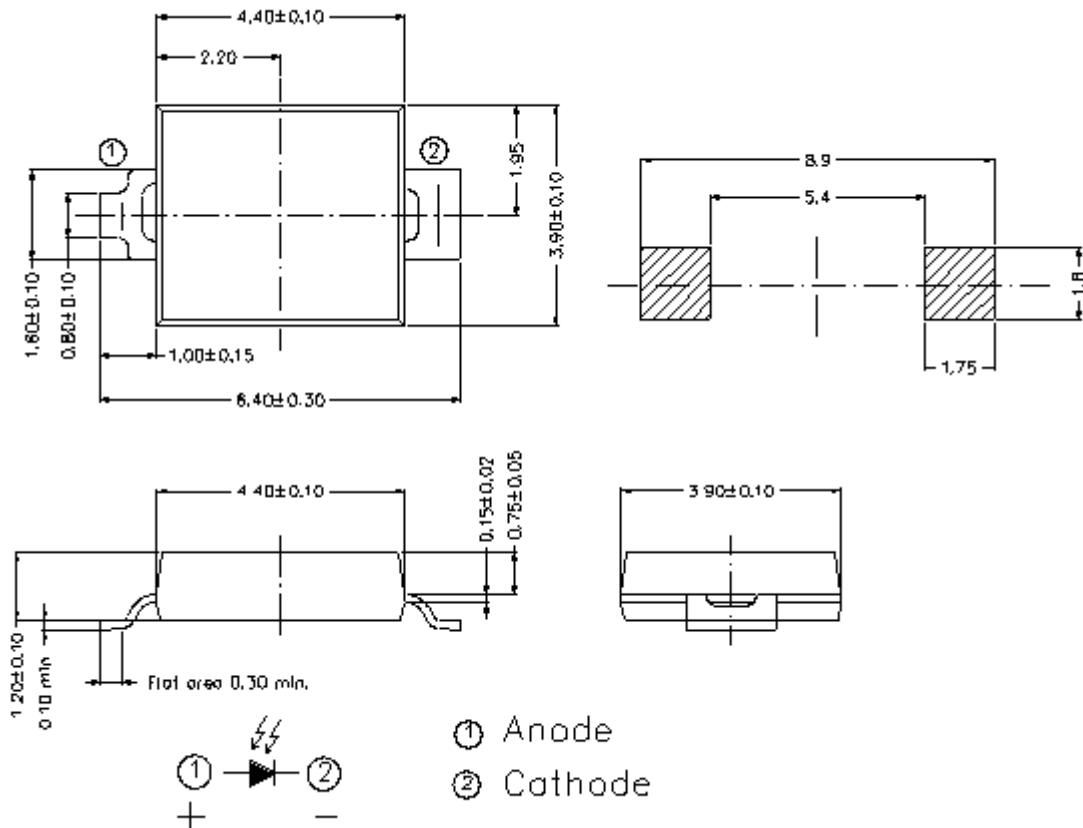

Notes: 1.All dimensions are in millimeters  
 2.Tolerances unless dimensions  $\pm 0.1\text{mm}$

Absolute Maximum Ratings ( $T_a=25^\circ\text{C}$ )

Parameter	Symbol	Rating	Units
Reverse Voltage	$V_R$	32	V
Operating Temperature	$T_{opr}$	-25 ~ +85	
Storage Temperature	$T_{stg}$	-40 ~ +85	
Soldering Temperature *1	$T_{sol}$	260	
Power Dissipation at(or below) 25 Free Air Temperature	$P_d$	150	mW

Notes: \*1:Soldering time 5 seconds.

**Electro-Optical Characteristics (Ta=25 )**

Parameter	Symbol	Condition	Min	Typ	Max	Unit
Rang Of Spectral Bandwidth	0.5	---	400	---	1100	nm
Wavelength Of Peak Sensitivity	p	---	---	940	---	nm
Short- Circuit Current	I <sub>SC</sub>	Ee=1mW/cm <sup>2</sup> p=875nm	---	35	---	μ A
Reverse Light Current	I <sub>L</sub>	Ee=1mW/cm <sup>2</sup> p=875nm V <sub>R</sub> =5V	17	25	---	μ A
Reverse Dark Current	I <sub>D</sub>	Ee=0mW/cm <sup>2</sup> V <sub>R</sub> =10V	---	5	30	nA
Reverse Breakdown Voltage	V <sub>BR</sub>	Ee=0mW/cm <sup>2</sup> I <sub>R</sub> =100 μ A	32	170	---	V
Temperature coefficient of V <sub>oc</sub>	TK <sub>Voc</sub>	Ee=1mW/cm <sup>2</sup> p=940nm	---	-2.6	---	mV/K
Temperature coefficient of I <sub>sc</sub>	TK <sub>Isc</sub>	Ee=1mW/cm <sup>2</sup> p=940nm	---	-0.1	---	%/K

**Typical Electro-Optical Characteristics Curves**

Fig.1 Spectral Sensitivity

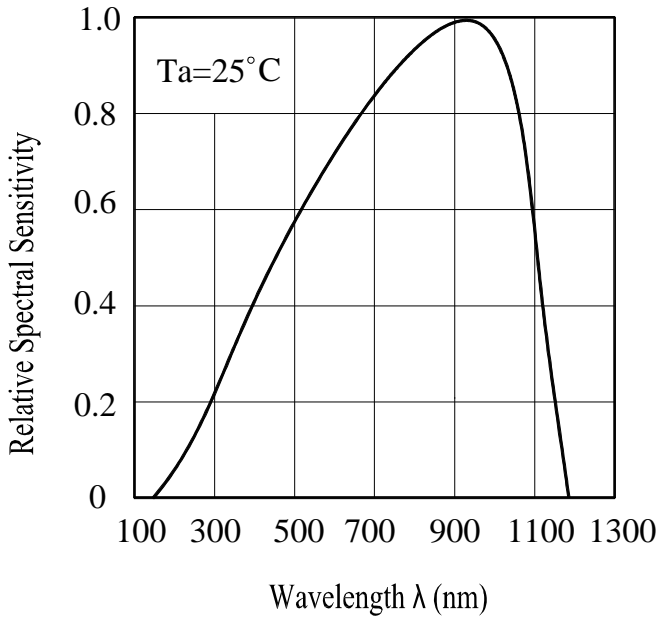
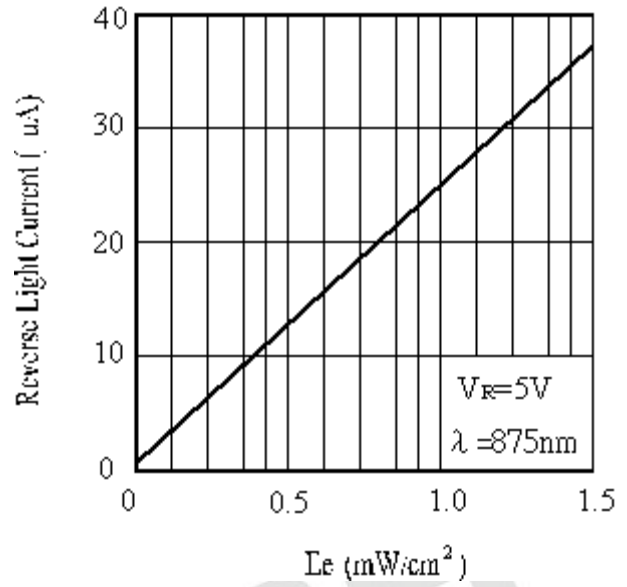

Fig. 2 Reverse Light Current vs.  $E_e$



## Precautions For Use

### 1. Over-current-proof

Customer must apply resistors for protection , otherwise slight voltage shift will cause big current change ( Burn out will happen ).

### 2. Storage

2.1 Do not open moisture proof bag before the products are ready to use.

2.2 Before opening the package, the LEDs should be kept at 30 or less and 90%RH or less.

2.3 The LEDs should be used within a year.

2.4 After opening the package, the LEDs should be kept at 30 or less and 60%RH or less.

2.5 The LEDs should be used within 168 hours (7 days) after opening the package.

2.6 If the moisture absorbent material (silica gel) has faded away or the LEDs have exceeded the storage time, baking treatment should be performed using the following conditions.

Baking treatment :  $60\pm 5$  for 24 hours.

### 3. Soldering Condition

#### 3.1 Pb-free solder temperature profile

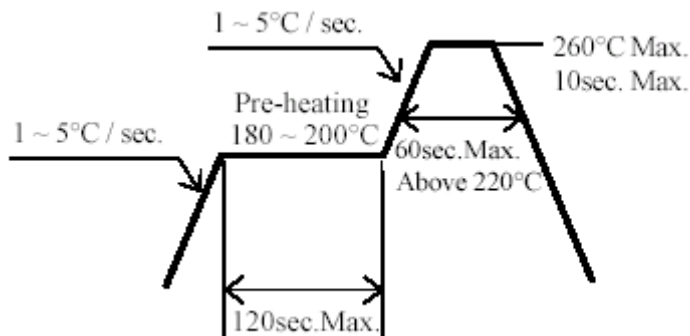

3.2 Reflow soldering should not be done more than two times.

3.3 When soldering, do not put stress on the LEDs during heating.

3.4 After soldering, do not warp the circuit board.

#### 4.Soldering Iron

Each terminal is to go to the tip of soldering iron temperature less than 350 for 3 seconds within once in less than the soldering iron capacity 25W. Leave two seconds and more intervals, and do soldering of each terminal. Be careful because the damage of the product is often started at the time of the hand solder.

#### 5.Repairing

Repair should not be done after the LEDs have been soldered. When repairing is unavoidable, a double-head soldering iron should be used (as below figure). It should be confirmed beforehand whether the characteristics of the LEDs will or will not be damaged by repairing.

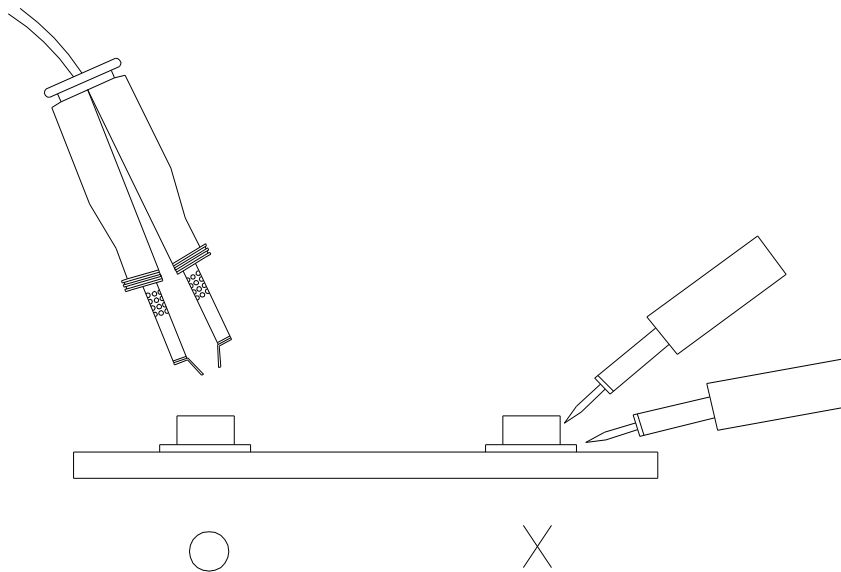

Package Dimensions

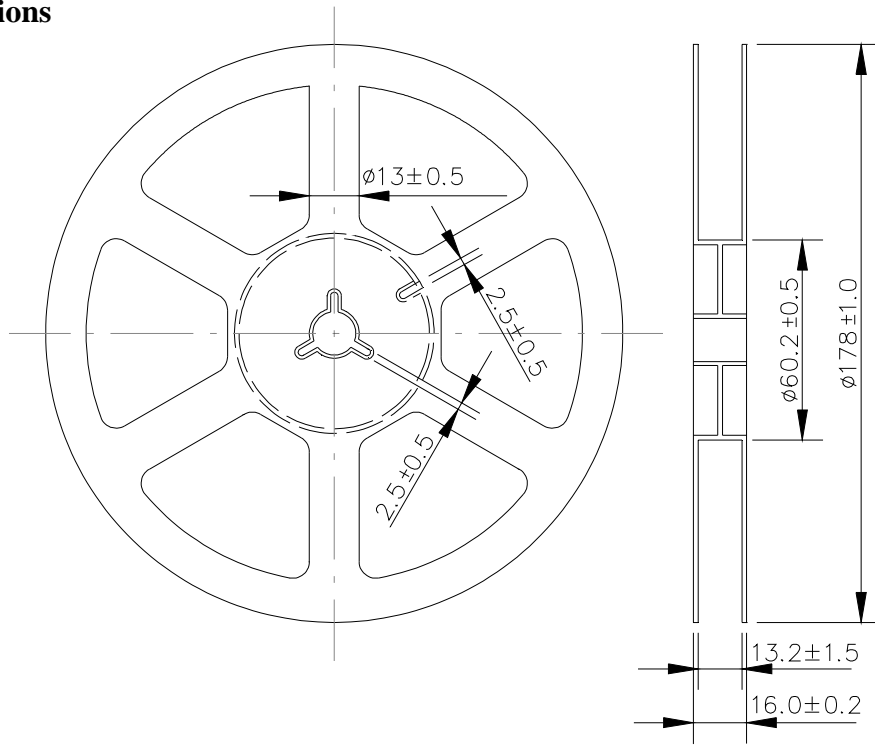

**Note:** The tolerances unless mentioned are  $\pm 0.1$ , unit=mm.

**Carrier Tape Dimensions:** (Quantity: 1000PCS/Reel)

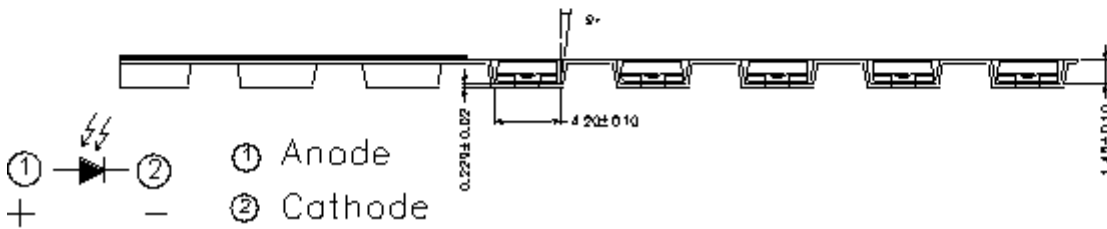
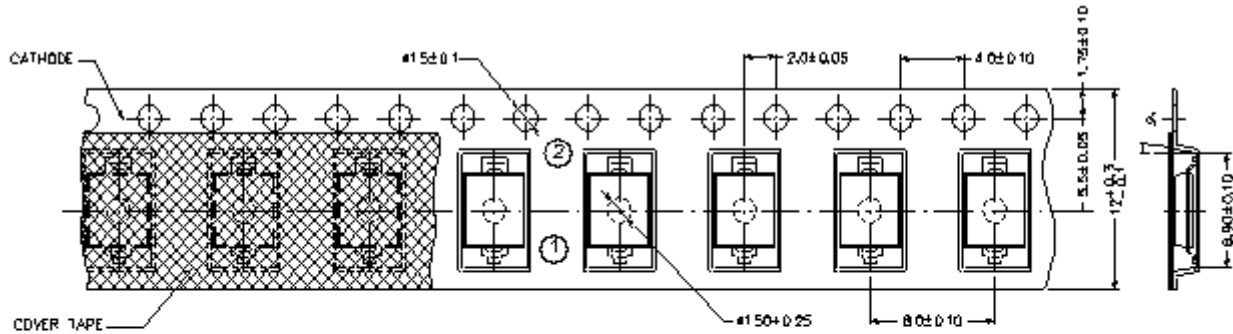

**Note:** The tolerances unless mentioned are  $\pm 0.1$ , unit=mm.

### Label Form Specification

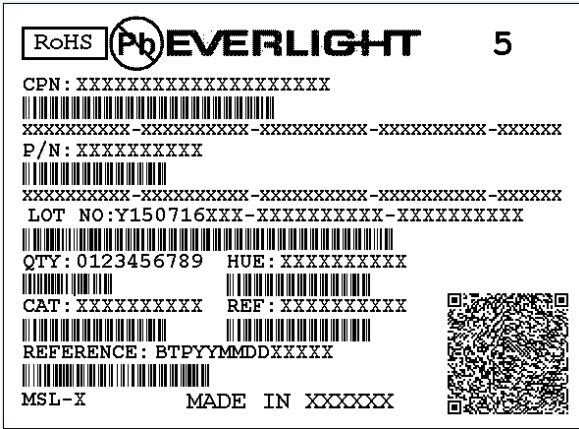

CPN: Customer's Production Number  
P/N : Production Number  
QTY: Packing Quantity  
CAT: Ranks  
HUE: Peak Wavelength  
REF: Reference  
LOT No: Lot Number

### Notes

1. Above specification may be changed without notice. EVERLIGHT will reserve authority on material change for above specification.
2. When using this product, please observe the absolute maximum ratings and the instructions for using outlined in these specification sheets. EVERLIGHT assumes no responsibility for any damage resulting from use of the product which does not comply with the absolute maximum ratings and the instructions included in these specification sheets.
3. These specification sheets include materials protected under copyright of EVERLIGHT corporation. Please don't reproduce or cause anyone to reproduce them without EVERLIGHT's consent.

<b>EVERLIGHT ELECTRONICS CO., LTD.</b> Office: No. 6-8, Zhonghua Rd., Shulin Dist., New Taipei City 23860, Taiwan	Tel: 886-2-2685-6688 Fax: 886-2685-2699 , 6897 <a href="http://www.everlight.com">http://www.everlight.com</a>
-------------------------------------------------------------------------------------------------------------------------	----------------------------------------------------------------------------------------------------------------------