

R6250SD

REED INSTRUMENTS

Data Logging Heat Stress Meter



Instruction Manual

REED Instruments

1-877-849-2127 | info@reedinstruments.com | www.reedinstruments.com

Table of Contents

| | |
|---|-------|
| Introduction | 3 |
| Product Quality | 3 |
| Safety | 4 |
| Features | 4 |
| Specifications | 5-6 |
| Included | 6 |
| Instrument Display | 7 |
| Display Description | 8 |
| Operating Instructions | 9-12 |
| <i>Power ON/OFF</i> | 9 |
| <i>Selecting Measurement Modes</i> | 9 |
| <i>Wet Bulb Globe Temperature Measurement Mode (_bgt)</i> | 9-10 |
| <i>Wet Bulb Temperature Measurement Mode (_b)</i> | 10 |
| <i>Dew Point Measurement Mode (dP)</i> | 10 |
| <i>Humidity/Air Temperature Mode (rH/tA)</i> | 11 |
| <i>Black Globe Temperature Mode (tg)</i> | 11 |
| <i>Data Hold</i> | 12 |
| <i>Recording Maximum and Minimum Readings</i> | 12 |
| <i>Backlight</i> | 12 |
| Setup Mode | 13-16 |
| <i>Setting the Time and Date (dAtE)</i> | 13 |
| <i>Setting WBGT Alarm Value (AL)</i> | 14 |
| <i>Setting Data Decimal Format (dEC)</i> | 14 |
| <i>Enabling/Disabling Auto Power Off (PoFF)</i> | 14 |
| <i>Enabling/Disabling the Beeper (bEEP)</i> | 14 |
| <i>Selecting the Temperature Unit of Measure (t-CF)</i> | 15 |
| <i>Setting the Data Logging Sampling Rate (SP-t)</i> | 15 |
| <i>Formatting the SD Card (Sd F)</i> | 15 |

continued...

| | |
|--|-------|
| Verify Set Time and Date | 15 |
| Verify Sampling Rate | 15 |
| Data Logging | 16-18 |
| <i>Data Recording Modes</i> | 16 |
| <i>Manual Data Logging Mode</i> | 16 |
| <i>Automatic Data Logging Mode</i> | 17 |
| <i>Transferring Data from the SD Memory Card to a Computer</i> | 18 |
| Data Stream Output | 19 |
| <i>3.5mm Terminal to RS-232 Serial Connection</i> | 19 |
| System Reset | 20 |
| Battery Replacement | 20 |
| Applications | 20 |
| Accessories and Replacement Parts | 21 |
| Frequently Asked Questions (FAQ's) | 21 |
| Product Care | 21 |
| Product Warranty | 22 |
| Product Disposal and Recycling | 22 |
| Product Support | 22 |

Introduction

Thank you for purchasing your REED R6250SD Data Logging Heat Stress Meter. Please read the following instructions carefully before using your instrument. By following the steps outlined in this manual your meter will provide years of reliable service.

Product Quality

This product has been manufactured in an ISO9001 facility and has been calibrated during the manufacturing process to meet the stated product specifications. If a certificate of calibration is required please contact the nearest authorized REED distributor or authorized Service Center. Please note an additional fee for this service will apply.

Safety

Never attempt to repair or modify your instrument. Dismantling your product, other than for the purpose of replacing batteries, may cause damage that will not be covered under the manufacturer's warranty. Servicing should only be provided by an authorized service center.

| | |
|--|---|
|  | <ul style="list-style-type: none">• Avoid electromagnetic interference which may cause erratic readings.• Do not touch the black ball during a test as the results may be inaccurate.• If the black ball is damaged or deformed, it will provide inaccurate measurement values. |
| CAUTION | Please place the meter in a warm temperature and low humidity environment for 24 hours after the meter has been exposed to an overly humid environment. |

Features

- Measures temperature, humidity, dew point, wet bulb, black globe, indoor/outdoor WBGT
- Wet Bulb Globe Temperature (WBGT) considers the effects of temperature, humidity and direct or radiant sunlight
- In/Out function displays the WBGT value with or without direct sun exposure
- Black Globe Temperature (TG) monitors the effects of direct solar radiation on an exposed surface
- Adjustable audible alarm
- User selectable unit of measure (°F or °C)
- Data hold and Max/Min functions
- Real-time datalogger with integrated SD memory card
- User selectable sampling rate from 1 to 3600 seconds
- Easy-to-read backlit LCD display
- Tripod mount for long-term monitoring
- Low battery indicator and auto shut off

Specifications

Temperature

| | |
|-------------------|---|
| Measuring Ranges: | Air: 32 to 122.0°F (0 to 50.0°C) Dew Point: -13.5 to 120.1°F (-25.3 to 48.9°C) Wet Bulb: -6.9 to 122.0°F (-21.6 to 50°C) Black Globe: 32 to 176°F (0 to 80°C) Indoor WBGT: 32 to 138°F (0 to 59°C) Outdoor WBGT: 32 to 132°F (0 to 56°C) |
| Accuracy: | Air: $\pm 1.5^\circ\text{F}$ ($\pm 0.8^\circ\text{C}$) Black Globe: $\pm 1.1^\circ\text{F}$ ($\pm 0.6^\circ\text{C}$) Indoor WBGT: $\pm 2.7^\circ\text{F}$ ($\pm 1.5^\circ\text{C}$) Outdoor WBGT: $\pm 3.6^\circ\text{F}$ ($\pm 2^\circ\text{C}$) |
| Resolution: | 0.1°F/°C |

Humidity

| | |
|------------------|---|
| Measuring Range: | 5 to 95% RH |
| Accuracy: | >70% RH: $\pm(3\% \text{ rdg} + 1\% \text{ RH})$ <70% RH: $\pm 3\% \text{ RH}$ |
| Resolution: | 0.1% RH |

General Specifications

| | |
|-------------------|---|
| Indoor Formula: | 0.7WB + 0.3TG |
| Indoor Range: | 32 to 138°F (0 to 59°C) |
| Indoor Accuracy: | $\pm 2.7^\circ\text{F}$ ($\pm 1.5^\circ\text{C}$) |
| Outdoor Formula: | 0.7WB + 0.3TG + 0.1TA |
| Outdoor Range: | 32 to 132°F (0 to 56°C) |
| Outdoor Accuracy: | $\pm 3.6^\circ\text{F}$ ($\pm 2^\circ\text{C}$) |
| Response Time: | 1 second |
| Display: | 4-digit dual LCD |
| Backlit Display: | Yes |
| Data Hold: | Yes |
| Min: | Yes |
| Max: | Yes |

continued...

REED Instruments

1-877-849-2127 | info@reedinstruments.com | www.reedinstruments.com

| | |
|---------------------------------|---|
| Datalogging Capabilities: | Yes |
| Real-Time Clock and Date Stamp: | Yes |
| Selectable Sampling Rate: | Yes (1, 2, 5, 10, 30, 60, 120, 300, 600, 1800, 3600 seconds) |
| External Memory: | Yes, expandable up to 16GB with SD card (optional) |
| Auto Shut-off: | Yes (after 10 minutes/off) |
| Kick Stand: | Yes |
| Tripod Mountable: | Yes |
| Low Battery Indicator: | Yes |
| Power Supply: | 6 x AA batteries or AC Adapter (optional) |
| Data Output: | Yes (RS-232) |
| Product Certifications: | CE |
| Operating Temperature: | 0 to 122°F (0 to 50°C) |
| Storage Temperature: | 14 to 140°F (-10 to 60°C) |
| Operating Humidity Range: | 10 to 85% |
| Dimensions: | Instrument: 7.0 x 2.7 x 1.8" (177 x 68 x 45mm) Black Brass Ball Diameter: 2.9" (75mm) |
| Weight: | 1.1lbs (515g) |

Included

- Soft Carrying Case
- Batteries

Instrument Description

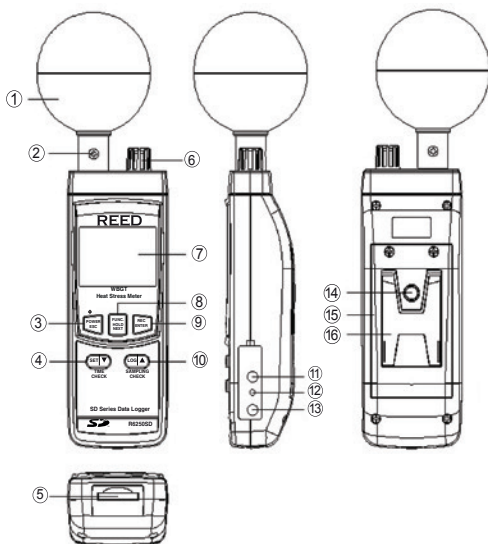

1. Black Globe Temperature Sensor
2. Black Globe Support Screws
3. POWER/Backlight/ESC Button
4. SET/Down/Time Check Button
5. SD Card Slot
6. Humidity/Air Temperature Sensor
7. LCD Display
8. HOLD/FUNCTION/NEXT Button
9. REC/ENTER Button
10. LOG/Up/SAMPLING CHECK Button
11. RS232 Output Jack
12. Reset Pin
13. Power Adapter Input
14. Tripod Mounting Screw
15. Battery Cover
16. Kickstand

REED Instruments

1-877-849-2127 | info@reedinstruments.com | www.reedinstruments.com

Display Description

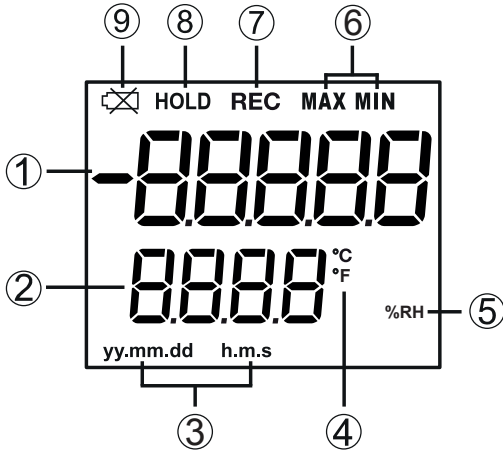

1. Measurement Reading Indicator
2. Date & Time Values/Measurement Modes Indicator
3. Date/Time Stamp
4. Temperature Unit of Measure
5. Unit of Measure
6. Maximum and Minimum Indicators
7. Record Mode Indicator
8. Data Hold Indicator
9. Low Battery Indicator

Operating Instructions

Power ON/OFF

1. Turn the meter on by pressing the **POWER** button. To turn the meter off, press and hold the **POWER** button for 2 seconds.

Note: This meter can be powered by either 6 x "AA" batteries or an AC adapter (sold separately).

Selecting Measurement Modes

The R6250SD offers 5 types of measurement modes to choose from:

- Wet Bulb Globe Temperature (WBGT)
- Wet Bulb Temperature (WB)
- Dew Point Temperature
- Humidity and Air Temperature (TA)
- Black Globe Temperature (TG)

1. When the meter is on, press and hold the FUNCTION button to scroll through the measuring modes. The display will flash "_bgt" (for Wet Bulb Temperature), "_b" (for Wet Bulb Temperature), "dP" (for Dew Point measurement), "tg" (for Black Globe Temperature), "rH/tA" (for Humidity/Air Temperature measurement).
2. Release the FUNCTION button to confirm selection.

Wet Bulb Globe Temperature Measurement Mode (*_bgt*)

1. Select the "_bgt" function (see *Selecting Measurement Modes* for details).
2. The top part of the display will indicate the WBGT value while the lower part of the LCD Display will indicate "_bgt in" for indoors or "_bgt out" for outdoors as shown below.

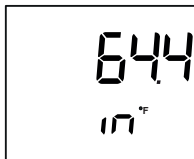
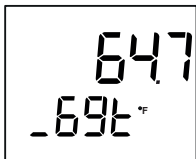

continued...

Note: "in" (indoor= without direct sun exposure) and "out" (outdoor= with direct sun exposure) modes.

3. While in measurement mode, hold "in/out" button to toggle between indoor or outdoor measurements.
4. To set the WBGT alarm, see *Setting WBGT Alarm Value* for details.

Wet Bulb Temperature Measurement Mode (_b)

1. Select the "_b" function (see *Selecting Measurement Modes* for details).
2. The top part of the display will indicate the WB value while the lower part of the LCD display will indicate "_b" as shown below.

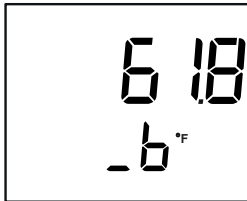

Dew Point Measurement Mode (dP)

1. Select the "dP" function (see *Selecting Measurement Modes* for details).
2. The top part of the display will indicate the Dew Point value while the lower part of the display will indicate "dP" as shown below.

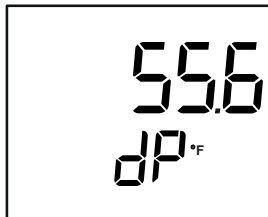

continued...

REED Instruments

1-877-849-2127 | info@reedinstruments.com | www.reedinstruments.com

Humidity/Air Temperature Mode (rH/tA)

1. Select the "rH/tA" function (see *Selecting Measurement Modes* for details).
2. The top part of the display will indicate the humidity value while the lower part of the display will indicate the air temperature value as shown below.

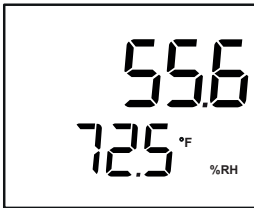

Black Globe Temperature Mode (tg)

1. Select the "tg" function (see *Selecting Measurement Modes* for details).
2. The top part of the display will indicate the black globe temperature value while the lower part of the display will indicate "tg" as shown below.

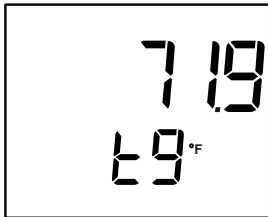

continued...

Data Hold

1. While taking a measurement, press the **HOLD** button to freeze the current measurement(s) on the display.
2. While in this mode a "HOLD" symbol will appear on the display.
3. Press the **HOLD** button again to resume normal operation.

Note: When the Data Hold feature is active all buttons except the **POWER** button are disabled.

Recording Maximum and Minimum Readings

1. Press the **REC** button to enter recording mode as indicated by "REC" on the LCD. The meter will now begin recording maximum and minimum readings.
2. While in recording mode;
 - A) Press the **REC** button once and the maximum value will appear on the display as indicated by "REC MAX".
 - B) Press the **REC** button again and the minimum value will appear on the display as indicated by "REC MIN".
 - C) To exit recording mode and resume normal operation, press and hold the **REC** button for two seconds.

When in recording mode the **POWER** button is disabled and the meter cannot be turned off.

Backlight

After powering the meter ON, the LCD Backlight will turn on automatically. Press the BACKLIGHT button to turn the LCD Backlight on or off.

Setup Mode

1. Press and hold the **SET** button for 2 seconds to enter Setup Mode.
2. Press the **NEXT** button continuously to scroll through the following parameters.

| Parameter | Description |
|-----------|--|
| dAtE | Set the time and date |
| AL | Set WBGT Alarm Value |
| dEC | Set the decimal format (USA (20.00) or European (20,00)) |
| PoFF | Enable or disable the auto-power off function |
| bEEP | Turn the beeper on or off |
| t-CF | Select the temperature unit of measure (°C or °F) |
| SP-t | Set the data logging sampling rate |
| Sd F | Format the SD memory card |

3. Once the appropriate parameter has been selected, follow the instructions below.

Note: The meter will automatically exit out of the Setup mode if no key is pressed within 7 seconds.

Setting the Time and Date (dAtE)

1. Press the **ENTER** button when "dAtE" appears on the LCD.
2. Press the **▲** and **▼** buttons to adjust the year as indicated by "YY".
3. Press the **ENTER** button to confirm selection.
4. Repeat steps 2 and 3 for month, day, hour, minute and seconds as indicated by (mm/dd/h/m/s).
5. After each value has been selected and confirmed, the meter will automatically skip to the next parameter.

Note: At any time, you can press the **ESC** button to exit the Setup mode and resume normal operation. The internal clock will keep accurate time when the meter is powered off. When new batteries are installed the clock will have to be reset.

continued...

Setting WBGT Alarm Value (AL)

Follow steps 1 and 2 when "AL" appears on the LCD.

1. Press the ▲ and ▼ buttons to adjust the WBGT alarm value.
2. Press the **ENTER** button to confirm selection and skip to next parameter.

Note: At any time, you can press the **ESC** button to exit the Setup mode and resume normal operation.

Setting Data Decimal Format (dEC)

Numeric formats vary in different countries. By default the meter is set to bASIC mode where a decimal point is used to separate units, (i.e. 20.00). The European format uses a comma (i.e. 20,00) to separate units. To change this setting, follow steps 1 and 2 when "dEC" appears on the LCD.

1. Press the ▲ and ▼ buttons to select between bASIC and Euro.
2. Press the **ENTER** button to confirm selection and skip to next parameter.

Note: At any time, you can press the **ESC** button to exit the Setup mode and resume normal operation.

Enabling/Disabling Auto Power Off (PoFF)

Follow steps 1 and 2 when "PoFF" appears on the LCD.

1. Press the ▲ and ▼ buttons to select between YES (enabled) or NO (disabled). With the Auto Power OFF feature enabled, the meter will automatically switch OFF after 10 minutes of inactivity to preserve battery life.
2. Press the **ENTER** button to confirm selection and skip to next parameter.

Note: At any time, you can press the **ESC** button to exit the Setup mode and resume normal operation.

Enabling/Disabling the Beeper (bEEP)

Follow steps 1 and 2 when "bEEP" appears on the LCD.

1. Press the ▲ and ▼ buttons to select between ON (enabled) or OFF (disabled).
2. Press the **ENTER** button to confirm selection and skip to next parameter.

Note: At any time, you can press the **ESC** button to exit the Setup mode and resume normal operation.

continued...

Selecting the Temperature Unit of Measure (t-CF)

Follow steps 1 and 2 when "t-CF" appears on the LCD.

1. Press the ▲ and ▼ buttons to select between °C and °F.
2. Press the **ENTER** button to confirm selection and skip to next parameter.

Note: At any time, you can press the **ESC** button to exit the Setup mode and resume normal operation.

Setting the Data Logging Sampling Rate (SP-t)

Follow steps 1 and 2 when "SP-t" appears on the LCD.

1. Press the ▲ and ▼ buttons to adjust the sampling rate between 0, 1, 2, 5, 10, 30, 60, 120, 300, 600, 1800, and 3600 seconds.
2. Press the **ENTER** button to confirm selection and skip to next parameter.

Note: At any time, you can press the **ESC** button to exit the Setup mode and resume normal operation.

Formatting the SD Card (Sd F)

Follow steps 1 through 5 when "Sd F" appears on the LCD.

1. Press the ▲ and ▼ buttons to select "YES" to format the card. Select "NO" to abort.
2. Press the **ENTER** button to confirm selection.
3. Press the **ENTER** button again to re-confirm.
4. The meter will format the SD card and automatically return to the Setup menu when formatting is complete.
5. Press the **ESC** button to exit the Setup mode and resume normal operation.

Note: It is recommended that new SD cards be formatted prior to first use. If the formatting process fails, the meter will display "-E-".

Verify Set Time and Date

During normal operation press the TIME CHECK button to display the year, month, date, hour, minute, seconds and selected sampling rate.

Verify Sampling Rate

During normal operation, press the SAMPLING CHECK button to view the selected sampling rate.

Data Logging

Data Recording Modes

Manual Data Logging: Press the **LOG** button to manually log up to 99 readings on a SD memory card (see *Manual Data Logging Mode* for full setup instructions).

Automatic Data Logging: Setup the meter parameters in order to automatically log data on a SD memory card. The number of data points is limited by the size of the memory card.

Note: It is recommended to use a class 4 SDHC memory card between 1 and 16Gb. Insert the SD memory card in the slot at the bottom of the meter. The card must be inserted with the label side facing the rear of the meter.

Manual Data Logging Mode

In manual mode, the **LOG** button is pressed to manually log a reading on the inserted SD card at any time. In order to setup the meter for manual data logging, follow steps 1 through 8 below.

1. Set the data logging sampling rate to "0" seconds (see *Setting the Data Logging Sampling Rate* section for details).
2. Press the **REC** button and "REC" will appear on the LCD.
3. The meter will also display P-X (X = memory position number between 1 and 99).
4. Press the **SET** button to enter the data memory positions section.
5. Press the **▲** and **▼** buttons to select one of the 99 data memory positions in which to record.
6. Press the **ENTER** button to confirm selection.
7. Press the **LOG** button again to save a reading to memory. "REC" will flash each time a data point is stored.

Note: If a card is not inserted or the card is defective, the meter will flash "CArD -E-". In this case, power the meter OFF and try again with another SD memory card or verify that the card is correctly inserted.

8. To exit manual data logging mode, press and hold the **REC** button 2 seconds to resume normal operation.

continued...

Automatic Data Logging Mode

In automatic mode the desired data logging sampling rate is set to 1, 2, 5, 10, 30, 60, 120, 300, 600, 1800 or 3600 seconds prior to recording (see *Setting the Data Logging Sampling Rate* section for details). In order to setup the meter for automatic data logging, follow steps 1 through 5 below.

1. To begin a data logging session Press the **REC** button and "REC" will appear on the LCD.
2. Press the **LOG** button. The meter will scan for a SD memory card.
Note: If a card is not inserted or the card is defective, the meter will flash "CArD -E-" indefinitely. In this case, power the meter OFF and try again with another SD memory card or verify that the card is correctly inserted.
3. The "REC" icon will appear on the LCD and will continuously flash while in a data logging session.
4. To pause the data logging session press the **LOG** button and "REC" will stop flashing. To resume press the **LOG** button again.
5. To end the current data logging session pause the data logging session and hold the **REC** button until "REC" disappears.

continued...

Transferring Data from the SD Memory Card to a Computer

1. While the meter is powered Off remove the SD memory card from the SD card slot.
2. Insert the SD memory card into the computer.
3. Open the file(s) with Excel. See sample below:

| Place | Date | Time | Value | Unit | Value | Unit | Value | Unit | Value | Unit | Value | Unit | Value | Unit |
|-------|----------|----------|-------|-----------|-------|-------|-------|-----------|-------|-----------|-------|------------|-------|-----------|
| 1 | 19-07-10 | 11:42:27 | 18 | WBGTemp C | 55.5 | %RH C | 22.3 | TA Temp C | 25 | TG Temp C | 20 | WET Temp C | 12.9 | DP Temp C |
| 2 | 19-07-10 | 11:42:29 | 25 | WBGTemp C | 65 | %RH C | 25 | TA Temp C | 30 | TG Temp C | 25 | WET Temp C | 12.9 | DP Temp C |
| 3 | 19-07-10 | 11:42:31 | 32 | WBGTemp C | 70 | %RH C | 30 | TA Temp C | 35 | TG Temp C | 35 | WET Temp C | 12.9 | DP Temp C |
| 4 | 19-07-10 | 11:42:33 | 35 | WBGTemp C | 75 | %RH C | 22.3 | TA Temp C | 40 | TG Temp C | 16.4 | WET Temp C | 12.9 | DP Temp C |
| 5 | 19-07-10 | 11:42:35 | 40 | WBGTemp C | 80 | %RH C | 22.3 | TA Temp C | 40 | TG Temp C | 38 | WET Temp C | 12.9 | DP Temp C |
| 6 | 19-07-10 | 11:42:37 | 38 | WBGTemp C | 78 | %RH C | 22.3 | TA Temp C | 25 | TG Temp C | 16.4 | WET Temp C | 12.9 | DP Temp C |
| 7 | 19-07-10 | 11:42:39 | 37 | WBGTemp C | 77 | %RH C | 35 | TA Temp C | 40 | TG Temp C | 16.3 | WET Temp C | 12.9 | DP Temp C |
| 8 | 19-07-10 | 11:42:41 | 36 | WBGTemp C | 55.3 | %RH C | 22.3 | TA Temp C | 20 | TG Temp C | 45 | WET Temp C | 12.9 | DP Temp C |
| 9 | 19-07-10 | 11:42:43 | 35 | WBGTemp C | 55.3 | %RH C | 22.3 | TA Temp C | 22.4 | TG Temp C | 16.3 | WET Temp C | 12.9 | DP Temp C |
| 10 | 19-07-10 | 11:42:45 | 41 | WBGTemp C | 55.3 | %RH C | 34 | TA Temp C | 22.4 | TG Temp C | 16.3 | WET Temp C | 12.9 | DP Temp C |
| 11 | 19-07-10 | 11:42:47 | 33 | WBGTemp C | 56.5 | %RH C | 22.3 | TA Temp C | 22.4 | TG Temp C | 48 | WET Temp C | 13.2 | DP Temp C |
| 12 | 19-07-10 | 11:42:49 | 18.4 | WBGTemp C | 58.1 | %RH C | 22.3 | TA Temp C | 22.4 | TG Temp C | 16.8 | WET Temp C | 13.6 | DP Temp C |

The raw data can be used to create a graph in Excel. See sample below:

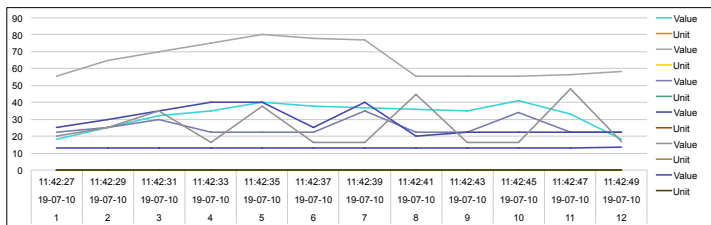

Data Stream Output

Using Terminal application, a data stream can be viewed from the RS-232 output, connect RS-232/USB cable between the product and terminal/PC and use the following setting to view the data stream.

Terminal Settings:

- Bits per second: 9600
- Data bits: 8
- Parity: None
- Stop bits: 1

41020100000654 = WBGT Value, 65.4 °F

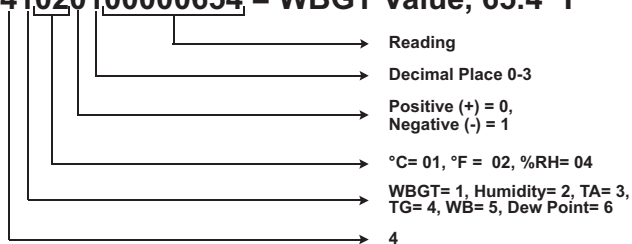

3.5mm Terminal to RS-232 Serial Connection

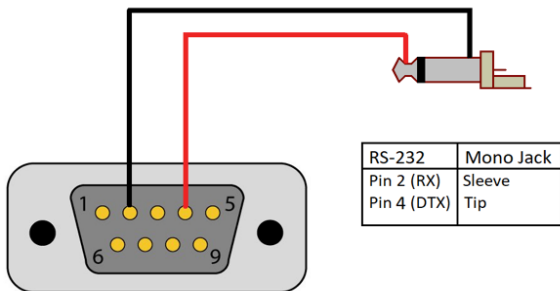

REED Instruments

1-877-849-2127 | info@reedinstruments.com | www.reedinstruments.com

System Reset

If the meter becomes unresponsive or if the display freezes the Reset pin can be used to reset the instrument.

1. Use a paper clip or any similar small object to press the Reset pin.
2. After pressing the Reset pin, power the meter back up by holding the **POWER** button for 2 seconds.
3. If resetting the meter does not resolve the issue, please return the meter to the nearest authorized REED distributor or authorized Service Center for repair.

Battery Replacement

When the low battery icon  appears on the LCD, the batteries must be replaced.

1. Remove the two (2) Phillips screws on the back of the meter directly located above the top of the kickstand.
2. Remove the battery cover.
3. Replace 6 x "AA" batteries.
4. Secure the battery cover with the two (2) Phillips screws.

Applications

- Sports (leisure, organized, and professional)
- Monitor seasonal conditions to ensure safe environment at school or daycare
- Ensuring safe work environments

Accessories and Replacement Parts

R1500 Tripod

RSD-ADP-NA Power Supply, 110V

RSD-ADP-EU Power Supply, 220V

CA-05A Soft Carrying Case

R8888 Deluxe Hard Carrying Case

SD-4GB 4GB Class 4 SDHC Memory Card

RSD-16GB 16GB Micro SD Memory Card w/ Adapter

Don't see your part listed here? For a complete list of all accessories and replacement parts visit your product page on www.REEDInstruments.com.

Frequently Asked Questions (FAQ's)

I cannot turn off my meter, do you know why?

Often times, the meter cannot be turned off because it is in recording mode ("REC" mode). Make sure to exit that function by holding down the **REC** button before attempting to turn the meter off.

How long can I record for?

Battery life will depend on a number of factors:

- Quality of Battery
- Whether the beeper is ON or OFF
- Whether the backlight is ON or OFF
- Environmental Conditions during data logging

As a reference, using alkaline batteries with both the backlight and beeper on while automatic data logging at a 2 second sampling rate; the batteries will last approximately 14 hours.

Product Care

To keep your instrument in good working order we recommend the following:

- Store your product in a clean, dry place.
- Change the battery as needed.
- If your instrument isn't being used for a period of one month or longer please remove the battery.
- Clean your product and accessories with biodegradable cleaner. Do not spray the cleaner directly on the instrument. Use on external parts only.

REED Instruments

1-877-849-2127 | info@reedinstruments.com | www.reedinstruments.com

Product Warranty

REED Instruments guarantees this instrument to be free of defects in material or workmanship for a period of one (1) year from date of shipment. During the warranty period, REED Instruments will repair or replace, at no charge, products or parts of a product that proves to be defective because of improper material or workmanship, under normal use and maintenance. REED Instruments total liability is limited to repair or replacement of the product. REED Instruments shall not be liable for damages to goods, property, or persons due to improper use or through attempts to utilize the instrument under conditions which exceed the designed capabilities. In order to begin the warranty service process, please contact us by phone at 1-877-849-2127 or by email at info@REEDInstruments.com to discuss the claim and determine the appropriate steps to process the warranty.

Product Disposal and Recycling



Please follow local laws and regulations when disposing or recycling your instrument. Your product contains electronic components and must be disposed of separately from standard waste products.

Product Support

If you have any questions on your product, please contact your authorized REED distributor or REED Instruments Customer Service by phone at 1-877-849-2127 or by email at info@REEDInstruments.com.

Please visit www.REEDInstruments.com for the most up-to-date manuals, datasheets, product guides and software.

*Product specifications subject to change without notice.
All rights reserved. Any unauthorized copying or reproduction of this manual is strictly prohibited without prior written permission from REED Instruments.*

REED Instruments

1-877-849-2127 | info@reedinstruments.com | www.reedinstruments.com

REED INSTRUMENTS

TEST & MEASURE WITH CONFIDENCE



Access our
Product Catalog

Over 200 portable test and
measurement instruments



REED Instruments

1-877-849-2127 | info@reedinstruments.com | www.reedinstruments.com

REED INSTRUMENTS

TEMPERATURE
& HUMIDITY



SOUND



MOISTURE



AIR VELOCITY



ELECTRICAL



REED Instruments

1-877-849-2127 | info@reedinstruments.com | www.reedinstruments.com